











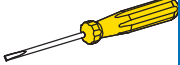











Einzelteilübersicht
Spare parts list
Liste des pièces détachées

Onderdelenoverzicht
Lista da piezas
Resumo de peça individual

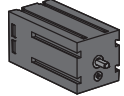
Singoli componenti
Перечень деталей
零件概览

	31 021 1 x		31 413 2 x		35 066 1 x		36 443 1 x
	31 058 1 x		31 915 1 x		35 073 2 x		37 238 8 x
	31 336 2 x		32 064 1 x		35 087 1 x		37 468 4 x
	31 337 2 x		35 031 1 x		35 945 1 x		37 858 1 x
	31 411 1 x		35 063 1 x		35 982 2 x		135 485 1 x
	31 412 2 x		35 064 3 x		36 382 1 x		137 196 1 x

- Alle Einzelteile, insbesondere bewegliche Teile sind falls notwendig zu warten und zu reinigen.
- All components, especially moving parts, should be maintained and cleaned as necessary.
- Toutes les pièces détachées et en particulier les pièces mobiles, sont, si nécessaire, à entretenir et à nettoyer.
- Alle onderdelen, vooral de bewegende delen, kunnen, indien noodzakelijk, onderhouden en gereinigd worden.
- Es necesario limpiar y mantener en buen estado todas las diferentes piezas - especialmente las piezas móviles.
- Caso necessário, todas as peças individuais, especialmente peças móveis, tem que ser submetidas à manutenção e ser limpas.
- Se necessario, tutti i singoli componenti, soprattutto le parti mobili, si devono eventualmente sottoporre a manutenzione e pulizia.
- Все детали конструктора, в особенности его подвижные части, необходимо содержать в исправности и очищать их по мере необходимости.
- 必要时应保养和清洁所有零件，尤指运动部件。
- Achtung
Verletzungsgefahr an Bauteilen mit funktionsbedingten scharfen Kanten und Spitzen!
- Caution
Be careful not to hurt yourself on components with sharp or pointed edges!
- Attention
Risque de blessure sur les éléments comportant des arêtes et o pointes vivants indispensables au bon fonctionnement!
- Let op
U kunt zich bezeren aan bouwstenen met scherpe randen of punten!
- Attenzione
Esiste il pericolo di lesione con i pezzi di costruzione che hanno bordi e punte spigolosi necessari per la funzionalità del pezzo!
- Atensão
Perigo de ferimentos em peças componentes com cantos vivos e pontas obrigatórios para o funcionamento !
- Attenzione
Pericolo di lesioni dovute a componenti con spigoli vivi e punte per motivi funzionali!
- Внимание!
Во избежание травм, будьте внимательны при обращении с острыми деталями!
- 注意
因功能需要而带有锋利的棱边和尖角的部件可能会带来受伤危险！

Montagen
Mountings
Montages

Montage`s
Montajes
Montagens

Montaggi
Сборка
儿童入门套餐

Kabel und Stecker
Plugs and cables
Fiches et des câbles

Stekkers en cables
Enchufes en cables
Cabos e contatos

Cavi e connettori
Штекеры и провода
电缆和插头

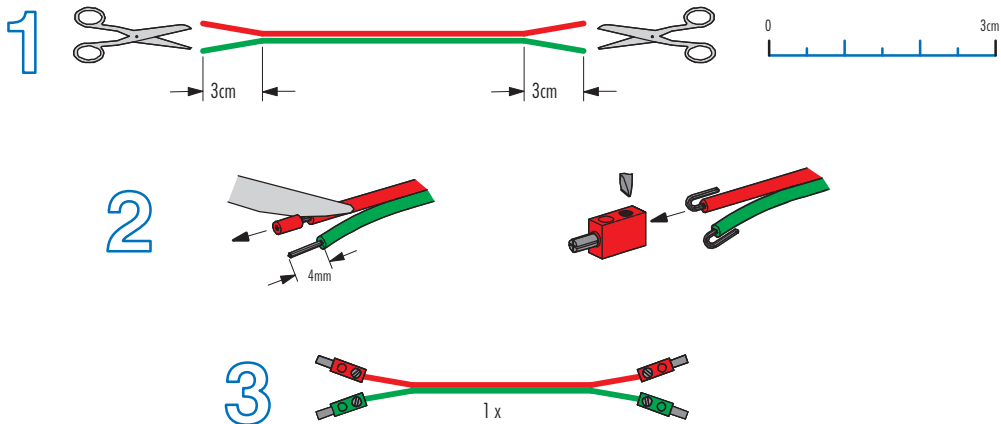

Stromversorgung
Power supply
Alimentation électrique

Stroomvoorziening
Alimentación de corriente
Alimentación de corriente

Alimentazione
Электропитание
电源供应装置

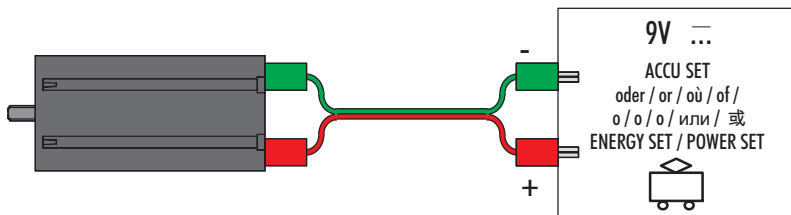

- Der XM-Motor enthält eine Sicherung, die den Motor bei zu großer Belastung bzw. zu hoher Temperatur abschaltet. Nach dem Abkühlen stellt sich die Sicherung von selbst zurück und der Motor kann wieder in Betrieb genommen werden.
- The XM-motor contains a circuit-breaker which shuts the motor off if the load on it is too great or its temperature is too high. When it has cooled off, the circuit-breaker resets itself and the motor can be started again.
- Le moteur XM contient une protection qui lors d'une charge trop importante ou d'une température trop élevée déclenche. Après le refroidissement, la protection revient elle-même en position et le moteur peut de nouveau être mis en marche.
- De XM-Motor is voorzien van een beveiligingsinrichting die de motor bij te grote belasting resp. te hoge temperatuur uitschakelt. Nadat de motor is afgekoeld, wordt de beveiligingsinrichting automatisch teruggezet en kan de motor weer worden gebruikt.
- El motor XM contiene un dispositivo de seguridad que desconecta el motor en caso de sobrecarga o de temperatura elevada. Una vez éste se enfría, el dispositivo de seguridad vuelve a accionarse y el motor puede ponerse de nuevo en funcionamiento.
- O "Motor XM" contém uma proteção, que desliga o motor no caso de sobrecarga grande de-mais respectivamente no caso de temperatura alta demais. Após o resfriamento a proteção se auto-recoloca e o motor pode ser colocado outra vez em funcionamento.
- Il XM-Motor contiene un circuito di sicurezza che spegne il motore in caso di carichi eccessivi o temperature elevate. Dopo il raffreddamento, il circuito di sicurezza si resetta automaticamente e il motore può essere rimesso in funzione.
- XM-Motor имеет предохранитель, который отключает двигатель при высокой нагрузке или температуре. После остывания предохранитель сам восстанавливается, и двигатель может работать дальше.
- 动力电机上有一个保险器，一旦电机的负荷过大或温度过高，该保险器便会关闭电机。冷却后保险器自动复位，可以重新将电机投入运行。

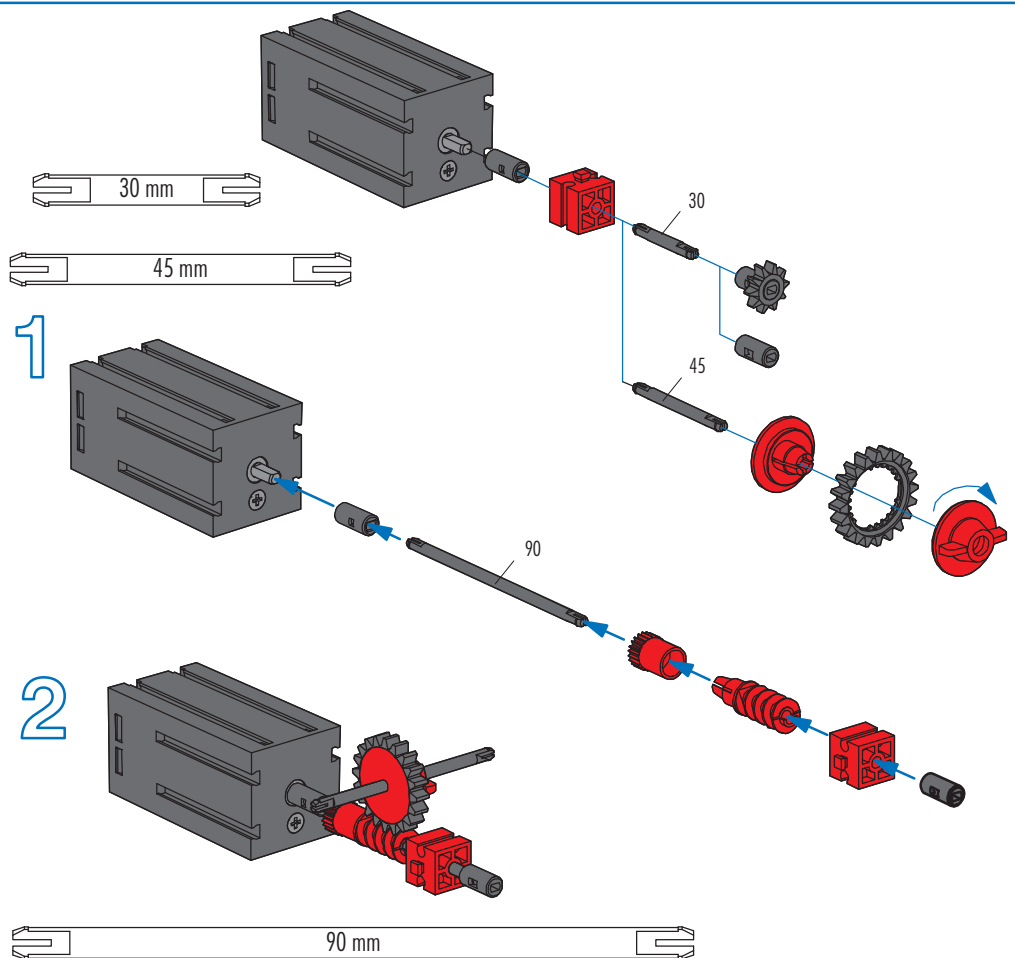

Differentialgetriebe für Radantrieb
Differential gears for wheel drive
Réducteur à différentiel pour entraînement de roue
Tandwielstelsel van differentieel voor wiel aandrijving
Mecanismo diferencial para el accionamiento de la rueda

Mecanismo de engranagem diferencial
para accionamento de rodas
Differenziale per comando ruote

Дифференциал для привода колес
用于车轮驱动装置的差速传动机构

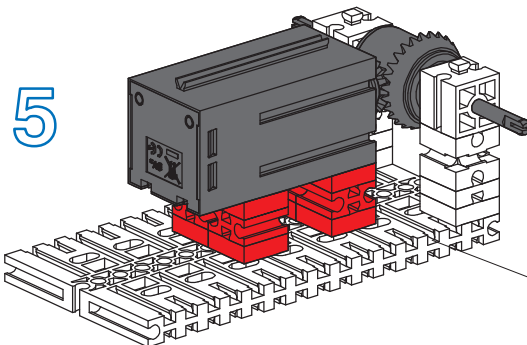
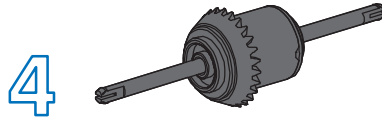
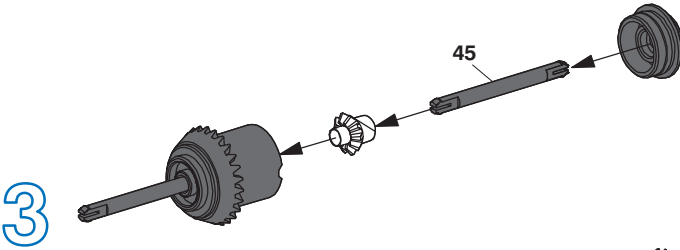
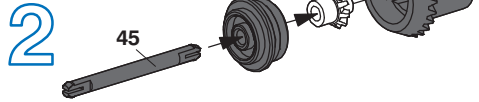
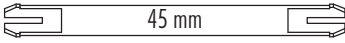
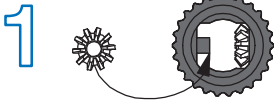

nicht im Baukasten enthalten
not included in the modular kit
n'est pas contenu dans le kit
niet in de bouwdoos opgenomen
no está incluido en el conjunto
não contido no sistema de construção por blocos
non inclusa nella scatola di montaggio
не входит в комплект конструктора
不包含在组件中